

Electronic Instant 4in1 Semi-Pro Hot Water Appliance



- ① Please read these instructions fully before commencing the installation and operation of the Electronic Instant Hot Water Appliance
- ① Tap and Filter must be installed before Boiling Tank
- ① Keep for future reference

Please read and fully understand this guide to the installation, operation and maintenance for your Instant Hot Water Appliance. Please read fully and If in doubt contact a qualified plumber or retailer to assist. Do not plug in the Instant Hot Water Tank until all water connections have been made and checked for being watertight. The Instant Hot Water Tank must be filled with water. The Instant Hot Water Tank is filled once water starts to pass out of the tap spout. It is recommended before using the tank, to flush through several litres of water before using to remove air from system.

For your safety and satisfaction please read all the instructions, cautions and warnings before installing or using this electronic instant hot water appliance.

This electronic instant hot water appliance is not intended for commercial use

IMPORTANT NOTICE: This product can cause harm if installed incorrectly and should only be installed by a competent person, if you feel for any reason unsure about the installation, please contact a qualified plumber or electrician to install the appliance.

Make sure all electrical wiring and connections conform to local standards.

Make sure all water connections conform to local standards.

Make sure all electrical wiring and water connections conform to local codes. Standard 220/240v grounded 13 amp switched electrical outlet is required under the sink. If possible, use a separate circuit dedicated to your Hot Tank.

The instant hot water appliance is an open vented system appliance. The operating pressure is 1.5 bar to maximum of 5 bar.

The water filter must be connected to the electronic instant hot water appliance and **re-placed every 6 months**, or the guarantee will be void.

These products are designed for the supply of Hot water for Drinks and Food only, and therefore fall outside the scope of ECO-DESIGN legislation requirements related to water heaters.

Equipment Required:

Tape Measure



Adjustable Wrench





WARNING: DO NOT USE PTFE TAPE WHEN INSTALLING. THIS CAN LEAD TO BLOCKAGES WITHIN YOUR TANK AND COULD INVALIDATE YOUR WARRANTY

SAFETY INSTRUCTIONS PLEASE READ BEFORE YOU START

The alert symbols displayed on the right point to important safety information to make you aware of potential hazards that can cause serious injury or death. Please pay special attention to the information following these warning alerts. Failure to comply with these instructions could result in property damage, serious injury or death.



Please read this chapter carefully for your own safety and the safety of those around you. Please read the safety information in this instruction, installation guide and on the product, in order to install and use the product accordingly, to avoid any injury. The safety information will tell you what the potential danger is, how to avoid it, and identify what will happen if you do not operate following the instruction.

Electric Shock: Using an ungrounded connection or improper connection of the power supply to the product can result in a serious injury or death from electrical shock.

Electric Shock: Do not remove the earthing terminal

Do not reconstruct the plug

Do not disassemble main box and any part for the power

IMPORTANT

The instructions are only intended as a guide, if there is any doubt then please contact a certified plumber or electrician or point of purchase and avoid using the appliance until it has been checked.

COMPONENTS INCLUDED

The electronic instant hot water appliance is supplied with the following:
Electronic Instant Hot Water Appliance with IEC power lead.

The water connections are to allow correct connections from the instant hot water tap to the electronic instant hot water Appliance.

Descale kit.

Outlet Connectors— 3/8" BSP to silicon

IMPORTANT SAFETY INSTRUCTIONS



PLEASE READ ALL INSTRUCTIONS CAREFULLY

When using all electrical appliances, basic safety precautions should always be followed including the information below:

To protect against electrical shock, do not place cord, plugs or unit near or in water or other liquids and do not operate the electronic instant hot water appliance controls or power socket with wet hands.

Check the power rating of your electronic instant hot water appliance is suitable for the power rating of the electrical circuit it is being installed on.

Do not operate or install the electronic instant hot water appliance if it appears to have any missing parts, be damaged / faulty e.g. damaged cord, plug.

Do not use outdoors or in a damp area.

Do not use the electronic instant hot water appliance for anything other than the intended **Domestic** use only.

The electronic instant hot water appliance must be installed vertically as shown on front cover with inlet and outlet connections at the top of appliance.

Ensure the front of the unit is visible and the front temperature dial can be easily reached.

Do not attempt to open, modify or service this electronic instant hot water appliance. Re-pairs should be carried out by Authorised Service personnel. Opening the unit will void the guarantee.

The instant hot water appliance is an open vented system appliance. The operating pressure is 1.5 bar to 5 bar

Turn off all controls before unplugging.

Do not unplug by pulling the cable. To unplug, grasp the plug, not the cable.

Property Damage: To avoid the risk of flooding, regularly inspect the connections for any signs of leakage.

This electronic instant water appliance is not intended for use by persons (including children) with reduced physical, sensory or mental capabilities, or lack of experience and knowledge, unless they have been given supervision or instruction concerning use of the appliance by a person responsible for their safety. Children should be supervised to ensure that they do not play with the electronic instant hot water appliance or instant hot water tap, a safety spring back handle is used to control the flow of the near boiling water for additional safety.

INSTALLATION REQUIREMENTS

Electrical Requirements

A 220/240-volt, 50 Hz, AC-only 13 amp fused, grounded electrical power supply is required. It is recommended that a separate circuit serving only your electronic instant hot water appliance be provided or use an outlet that can be turned on/off by a switch.

This electronic instant hot water appliance is equipped with a power supply cord with a power plug. To minimise possible shock hazard, the cord must be plugged into mating, ground-type outlet, grounded in accordance with all national and local codes and ordinances. If a socket outlet is not available, it is the responsibility and obligation of the customer to have a properly grounded outlet installed by a qualified electrician.

INSTALLATION REQUIREMENTS

Water Supply Requirements

If local codes permit, the instant hot water tap feed line should be connected to the hot and cold-water supply line using an isolation valve or another means for providing the hot and cold water to the tap.

IMPORTANT: If local codes do not permit the use of isolation valves, special feed valves can be obtained from your local plumbing supply distributor.

If the water is mixed with impurity, ironing chips, grains of sand, and so on, the pipes of the electronic instant hot water appliance and tap will be blocked and will void the guarantee.

Environment requirement

Don't install the electronic instant hot water appliance outdoors or in a location that may fall below zero degrees C, otherwise the pipes and the tap and tank will be frozen and there will be serious safety trouble, possible bodily-injury, accidents and damaged caused and the guarantee will be void.

It's forbidden to wash the electronic instant hot water appliance with water directly.

The installation environment should be ventilated, with protection from the direct sunshine. When installing the electronic instant hot water appliance, provide approximately 10cm to 15cm (4 - 5 ½") of air space on the sides of the unit for air circulation and approximately 2.5cm (1") from the mounting wall.

The environment humidity should be in the range of 10% to 60%. Be sure there is no dew.

Instant Hot Water Appliance Information

Connecting a standard tap may cause injury and will damage the electronic instant hot water appliance and void the guarantee. Due to high water temperature, and for safety reasons, the electronic instant hot water appliance is not under pressure.

INSTALLATION REQUIREMENTS

Instant Hot Water Appliance Temperature Adjustment

For temperatures above 95°C:- it has been set for optimum performance in most common and typical known installations. However, there are factors which may influence the performance of the instant hot water appliance such as incoming water temperature, atmospheric pressure and altitude.

Should you experience any discharge of water from the spout during heat up, you can reduce the setting to compensate for this by 1– 2°C degrees. If in doubt, please ask your dealer for further guidance.

PREPERATION FOR INSTALLATION

Unlike other household hot water appliances, this electronic instant hot water appliance is Non-Pressurised for safety reasons. For this electronic instant hot water appliance, the Instant Hot Tap is placed before the electronic instant hot water appliance, creating an “open vent” system and consequently no pressure is built up inside the appliance.

IMPORTANT: Install the Instant Hot Water Appliance in accordance with the fitting Instructions provided with the Hot Water Appliance.



Preparation for the Electronic Instant Hot Water Semi- Pro Appliance installation

IMPORTANT: Observe all local governing codes and ordinances

The electronic instant hot water appliance must be mounted vertically and level.

Before you begin, select a proper location ideally directly under the instant hot water tap or close to it to ensure the connection pipes will connect from the instant hot water tap to the electronic instant hot water appliance.

The electronic instant hot water appliance is not under pressure, consequently, there is a slight delay in water flow after the hot water spring back tap handle has been turned on. This is normal and indicates that the electronic instant hot water appliance is functioning properly.

It is recommended that you have access to a separate power circuit serving only your electronic instant hot water appliance.

INSTALLATION REQUIREMENTS

Regulations Requirements :

It is important to ensure that the water supplies to your tap, is connected in accordance with the water regulation requirements, plumbing code and good plumbing practice.

Water Supply Pressures :

This tap has been designed to function with a minimum supply pressure for cold water of 1.5bar. The Maximum supply pressure must not exceed 5 bar. Should excessive pressure be experienced, a Pressure Reducing Valve must be used.



Important:

Care and Maintenance of the Tap:

Only clean the tap with a soft cloth, warm water and a mild detergent solution. Rinse the tap clean thoroughly afterwards with water. Do not use any abrasive or harsh chemical products; otherwise, this will invalidate your guarantee.

The electronic instant hot water appliance inlet connection is a 3/8" BSP male threaded connector. The outlet connector is a 3/8" BSP male thread connector. Check the connections type and size on the instant hot water tap for the inlet and outlet connections.



Descaling Requirements :

The filter system provided with your hot water system will help to prevent scaling of the boiler and give better tasting water. The filter will reduce the need to descale your water system but does not eliminate it. To ensure maximum efficiency and product life of your machine, it will be required to descale, drain and refill the system every 6 months or possibly earlier, especially in hard water areas and whenever you see the flow of water starting to slow down. Ensuring the filter is replaced as required and is set up correctly, will reduce the frequency of required descaling. If you are finding the system requires frequent descaling, then you will need to replace the filter more frequently.

for purchasing the Instant Hot Water Semi-Pro Tank System

REGISTER YOUR PURCHASE



TO ACTIVATE YOUR PRODUCT'S WARRANTY, SIMPLY REGISTER YOUR PRODUCT AT

www.watersolutionsdirect.com



Scan QR code using your mobile device

Benefits of registering your product and creating an account:

- Validate your warranty
- Get direct, quick access to personal customer service and guarantee information
- Access troubleshooting and product care instructions
- Purchase filters and descaling kits for your product
- Receive exclusive product promotions

RECORD THIS INFORMATION

Serial Number: _____

Date of Purchase: _____



TIP: You can find the serial number on the top of your Hot Water Tank



TIP: It is the responsibility of the consumer to register their product



TIP: Failure from the consumer to register their product could invalidate warranty

PLEASE READ CAREFULLY AND KEEP FOR FUTURE REFERENCE.

ALL PRODUCTS MUST BE REGISTERED BY THE CONSUMER

AT WWW.WATERSOLUTIONSDIRECT.COM FOR CUSTOMER SERVICE, SUPPORT & SERVICE PARTS.

The approved filter supplied for this appliance must be replaced every 6 months. Descaling of your appliance is required every 6 months or sooner if your water flow seems slower.

INSTALLATION

Regulation Requirements

It is important to ensure that the water supplies to your tap, is connected in accordance with the water regulation requirements, plumbing code and good plumbing practice

Water Supply Pressures

This tap has been designed to function with a minimum supply pressure for cold water of 1.5bar. The maximum supply pressure must not exceed 5bar. Should excessive pressure be experienced, a Pressure reducing Valve must be used.

Care and Maintenance of the Tap:

Only clean the tap with a soft cloth, warm water and a mild detergent solution. Rinse the tap clean thoroughly afterwards with water. Do not use any abrasive or harsh chemical products; otherwise, this will invalidate your guarantee.

The electronic instant hot water appliance inlet connection is a 3/8" push fit connection. The outlet connector is a 3/8" BSP male thread connector. Check the connections type and size on the instant hot water tap for the inlet and outlet connections.

Step 1– Position the Instant Hot Water Appliance



Ensure the electronic instant hot water appliance is NOT connected to the Electric Power during installation.

Place the electronic instant hot water appliance in position and check to ensure that the instant hot water tap connection pipes and the power cord will reach without being stretched.

The electronic instant hot water appliance must be positioned so the tubes from and to the instant hot water tap do not twist or kink.

INSTALLATION CONTINUED

Step 2 – Connect Tap

Should you require any advice on the installation then please seek guidance from your retailer or a qualified plumber.

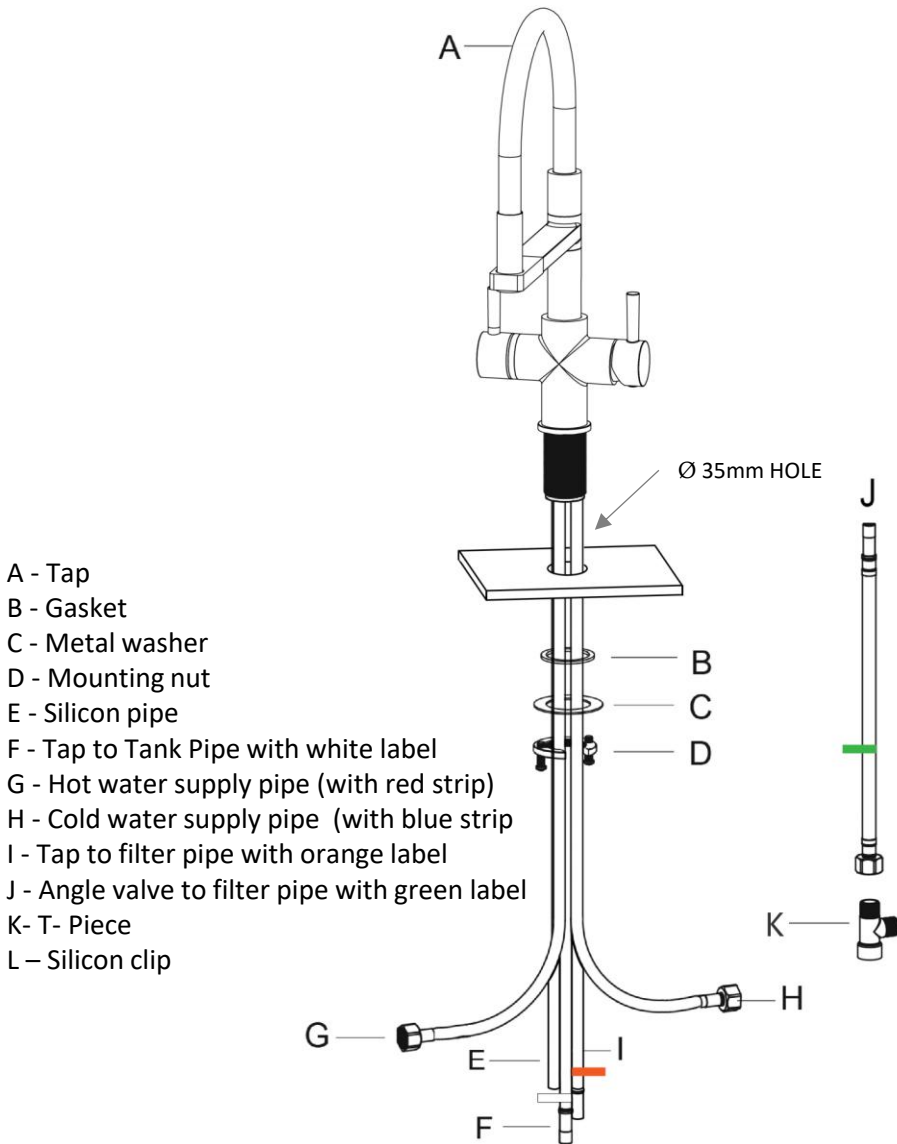

INSTALLATION CONTINUED

- 1) Feed the flexible connections through the work surface hole $\varnothing 35\text{mm}$.
- 2) Ensure the tap is orientated correctly i.e. The spout fixing screw should be at the back. The hot water lever should rotate to point backwards.
- 3) Feed flexible connections through the gasket (B) and metal Washer (C). Secure the tap in position using mounting nut (D).



Avoid kinking tubes during installation as this could restrict flow and cause malfunctioning of appliance. Do not use pipe sealing compounds on any connections. These can foul the internal mechanics and may cause objectionable taste and odour. Plumbing connections must comply with all sanitary, safety and plumbing standards.

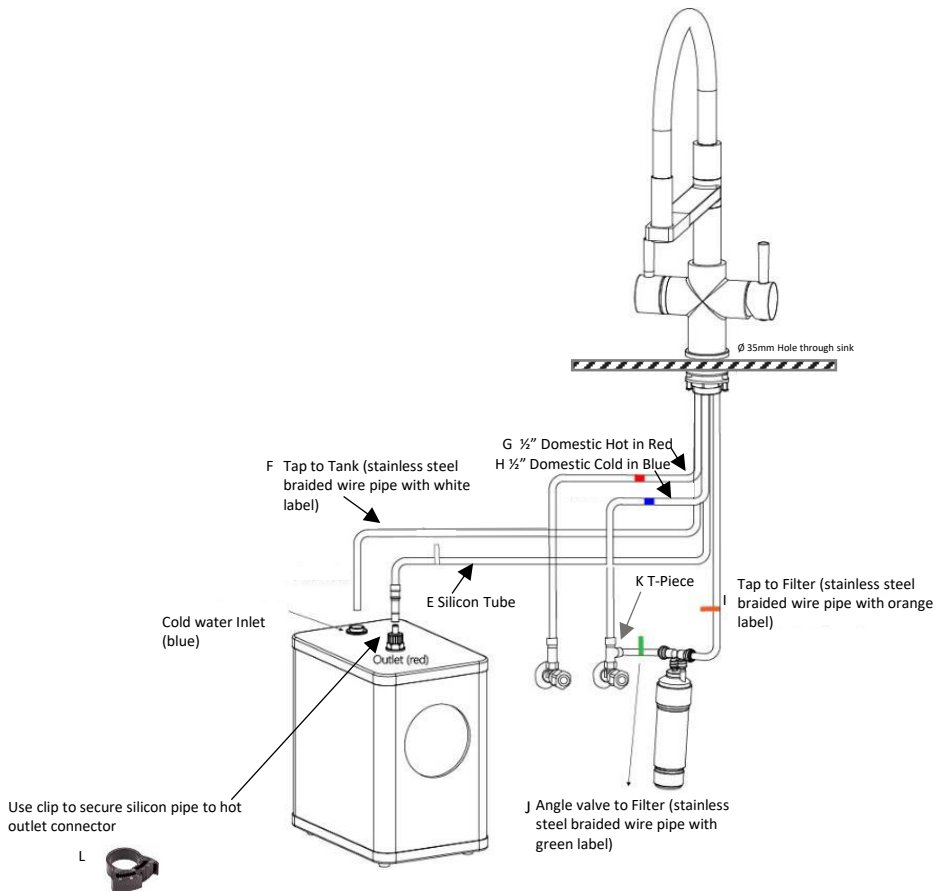

INSTALLATION CONTINUED

Step 3 – T Piece Installation

- Connect the 1/2" BSP T-piece to the cold-water supply valve. Hand tight plus a quarter turn.
- Connect BSP 1/2"-3/8" push fit to the T-Piece. Hand tight plus a quarter turn.
- Connect the tap cold water supply pipe to the 1/2" BSP T-piece.
- Connect the tap hot water supply pipe to the hot water supply valve.

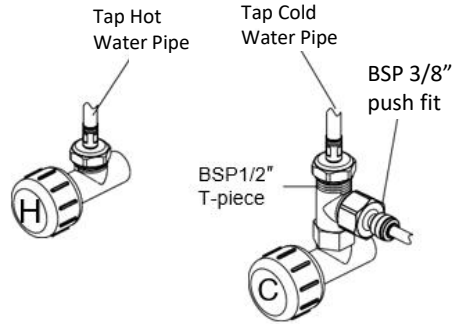

Step 4 – Water Supply Connections

When connecting the Hot & Cold tap supply pipes to the hot & cold mains supply, tighten hand tight plus quarter of a turn

*** Do Not Over Tighten**

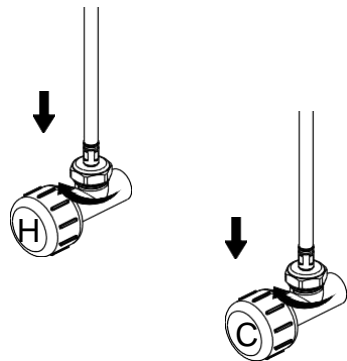

FILTER INSTALLATION



1. Remove cap and blue dust caps from filter (if needed)
2. New filter with covers and caps removed. Note IN and OUT connection Markings.

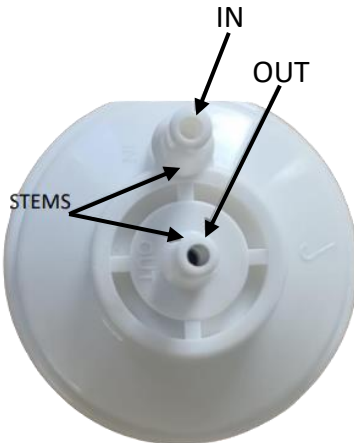

FILTER INSTALLATION

3. Push smaller diameter of elbow push fit fittings fully on to the **IN** and **OUT** stems of the filter (you will feel them click when fully inserted into position on the filter) as shown below



4. Push back grey ring and pull flexi hoses to remove from installed filter.

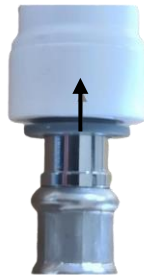

5. Fit flexi pipe from t-piece with green label to the inlet (**IN**) on the water filter. Pressing in firmly until feel click into position.

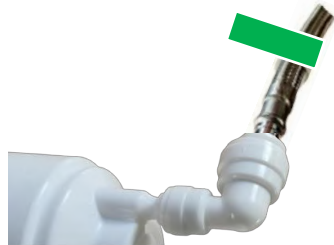

6. Fit orange label flexi pipe to the **OUT** connection on the new water filter to connect to tap.



7. Turn on tap and check for leaks.

FILTER INSTALLATION

Using Bracket -

1. If you would like to use the bracket to fix the filter inside your cupboard then simply locate desired position, ensuring all pipes reach to filter from tap and tank.
2. Hold bracket and use a pencil to mark through the hole in center of bracket.
3. Use a screwdriver to fasten the bracket with the woodscrew provided into position. As seen on Fig. A

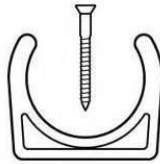
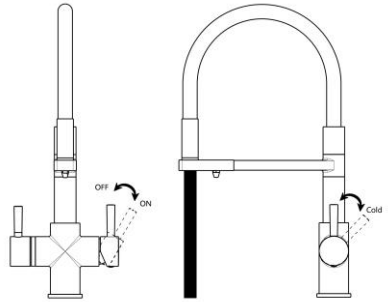

Fig. A

OPERATING THE TAP

To dispense Mains Cold Water – pull right lever outwards and push backwards.



To dispense Mains Hot Water – pull right lever outwards and pull forwards.

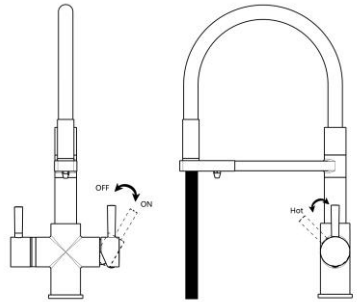

To dispense Cold Filtered Water – pull right lever forwards.

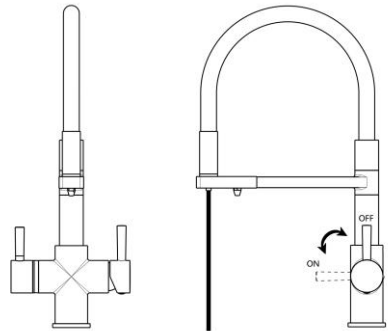

To dispense Boiling Water – hold lever on left hand side and push backwards.

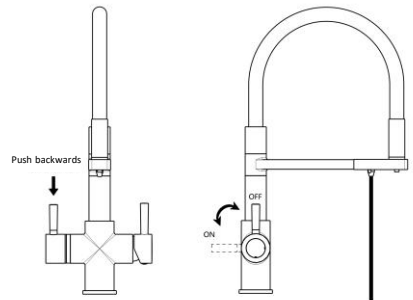

INSTALLATION CONTINUED

Step 5 - Priming and Checking for Water Tightness

Before the electronic instant hot water appliance is plugged into the power socket it must be tested for water tightness and no leaks.

Open all supply water valves to allow water to flow to the instant hot water tap. To fill the tank, press the spring back lever on hot side down and rotate to dispense water. When the electronic instant hot water appliance is full, water will flow from the instant hot water tap spout.



Turn the instant hot water handle off and check all connections for water tightness and leaks.

Any leaking joint must be tightened to ensure no water leakage and the above priming undertaken again and checked for water tightness before connecting to the power socket. **DO NOT USE ANY PIPE SEALING COMPOUNDS.**

Once sure system is watertight, dispense at least 2 litres of water to remove air from system.

Step 6 – Electrical Connection

Ensure that the installation area is dry and no water has spilled.

Always make sure that you have fully inserted the IEC power lead into the IEC socket in the tank before switching the power on. Do not plug the power lead in and try to attach to the tank IEC with the power on.

Connect the plug to the power socket and turn on the power socket at the switch.

The electronic instant hot water appliance display panel will now light up with the on / off button illuminated.

DISPLAY

HEATING INDICATOR

FILTER CHANGE INDICATOR

SET TEMPERATURE

CURRENT TEMPERATURE

TEMP/TIME DOWN

TEMP/TIME UP









CONFIRM BUTTON

ECO BUTTON

POWER ON/OFF





SETTING THE TIME

1. Turn on machine by pressing 
2. Press   simultaneously for 1 second to display current time
3. Press   to select hour. When the correct hour is reached press the  button.
4. The screen will now flash the minutes. Use the   arrows to select the minutes. When the correct minute is reached press the  button.
5. The correct time will now display on the screen before moving on to setting the required temperature.



SETTING THE TEMPERATURE



1. Press  to select the desired temperature for your machine.
2. The programmed temperatures are 75°C; 85°C; 90°C; 95°C; 96°C; 97°C & 98°C
3. When required temperature is shown press 
4. When water is detected for the first time, there will be a delay of about 15 seconds before heating is started to ensure that the tank has adequate water to heat



The light red-light circle will then alight from left to right to indicate machine is heating up. When set temperature is reached the circle will remain fully lit.





SETTING ECO ON AND SETTING ECO TIMES

The Eco mode has been designed to save energy, by putting the tank into standby during times, when it will not be used. For instance - whilst asleep at night or when out at work. You can set the Eco Mode twice a day for times you want your machine to be on or off.

1. Press  button to switch the ECO mode on and off. After switching it on, press the  button within 5 seconds to set the ECO time.

2. The machine will show ON with the hour flashing. Use the   buttons to select the hour and press the  button. The minutes will then flash.



Use the   buttons to select the minutes and then press 



The time that the machine will enter eco mode is now set. It will automatically move to setting when you would like Eco Mode to turn off



ECO MODE SET FOR
08.30 TO BE
ACTIVATED

SETTING ECO OFF AND SETTING ECO TIMES

3. The machine will show OFF with the hour flashing. Use the   buttons to select the hour and press the  button. The minutes will then flash.

Use the   buttons to select the minutes and then press .



ECO MODE
SET TO BE
DEACTIVATED
AT 20.30

This is your first set of timings for Eco Mode. The machine allows two sets of Eco Mode time settings for your convenience.

Repeat the above steps to set the 2nd set of timings.

When Eco Mode is active the Eco button will be lit and when it is not active the Eco button will be off.

TURNING ECO MODE ON/OFF

For ultimate convenience, Eco-Mode can be deactivated at any time by simply tapping the Eco button. To reactivate Eco-Mode simply tap the eco button again – the tank will then use Eco-Mode times previously programmed.

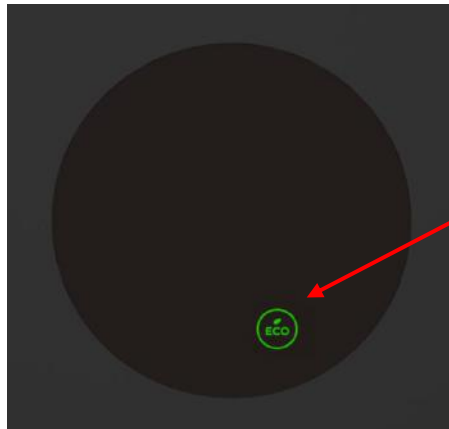

ECO BUTTON IS
ILLUMINATED
WHEN MACHINE
IS IN ECO MODE

CHANGING THE FILTER

For convenience, your hot water tank will remind you at 6 months that it is time to change the filter. 5 months after you set up your tank, the filter light will illuminate. 1 month after this the tank will beep 3 times on the hour between the hours of 9am and 9pm. You must now fit a new filter to keep you machine running at optimum performance and to ensure your warranty conditions are met.

Once you have fitted a new filter simply press the  and  buttons

simultaneously to reset your machine. This will reset the filter change reminder to 6 months.

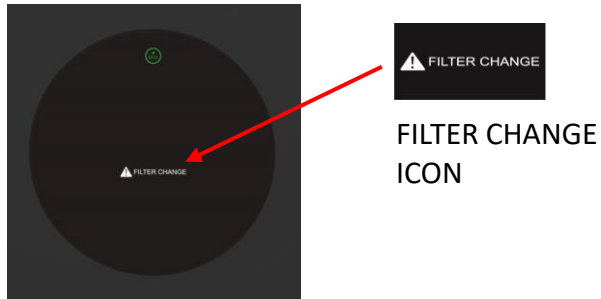

**ALL PRODUCTS MUST BE REGISTERED BY THE CONSUMER
AT WWW.WATERSOLUTIONSDIRECT.COM FOR CUSTOMER SERVICE, SUPPORT &
SERVICE PARTS.**

The approved filter supplied for this appliance must be replaced every 6 months. Descaling of your appliance is required every 6 months or sooner if your water flow seems slower.

To avoid invalidating your warranty see the user guide and register your product at

WWW.WATERSOLUTIONSDIRECT.COM

for details on replacing filters and descaling.

**FAILURE BY THE CONSUMER TO DO ANY OF THE ABOVE MAY INVALIDATE
YOUR WARRANTY.**

DESCALING YOUR APPLIANCE



FOLLOW ALL INSTRUCTIONS CAREFULLY

The filter system provided with your hot water system will help to prevent scaling of the boiler and give better tasting water. The filter will reduce the need to descale your water system but does not eliminate it.

In order to ensure maximum efficiency and product life of your machine, it will be required to descale, drain and refill the system every 6 months or possible earlier, especially in hard water areas.

Ensuring the filter is replaced as required and is set up correctly, will reduce the frequency of required descaling. If you are finding the system requires frequent descaling, then you will need to replace the filter more frequently.



WARNING: Harmful if swallowed. Irritating to eyes and skin

KEEP OUT OF REACH OF CHILDREN

Avoid contact with skin and eyes. In case of contact with eyes, rinse immediately with plenty of water and seek medical advice. After contact with skin, wash immediately with plenty of water.

If swallowed, seek medical advice immediately and show the container or label.

FOLLOW MANUFACTURER'S GUIDELINES

The descaling chemical is acidic and should only be used and handled as indicated. Care should be taken not to ingest, expose to skin, clothing or decorative surfaces. Take care when touching all surfaces and when disconnecting or connecting hoses - they may be hot and or generate steam, you must use personal protective wear to prevent accidental scalding.

DESCALING YOUR APPLIANCE

Included in your purchase of the Hot Tank System is a funnel and descaling kit. Future purchases can be made at

WWW.WATERSOLUTIONSDIRECT.COM

You will need:



Safety goggles



Adjustable



Rubber Gloves



Measuring jug



Funnel



1 packet of descale



Tweezers



We strongly recommend only using our descaling solution to avoid accidental damage to the product which may be caused by more aggressive alternatives. This may also invalidate any warranty

DESCALING YOUR APPLIANCE

1. Press and hold the power button to activate, this will put the boiler into standby mode.
2. Turn the boiling tap handle on fully. Run for at least 3 litres or until the stream of water runs fully cold.
3.  **TURN OFF WATER SUPPLY VALVE**
4. Pull out the mains power plug from the rear of the boiler.
5. Firmly pull the silicone rubber hose (C) off from the connector (D).

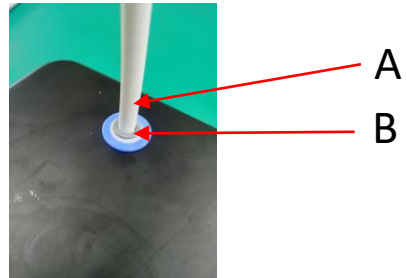
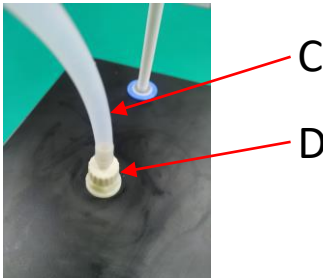

6. Unscrew flexible hose (A), using 19A/F spanner or adjustable spanner, from the top of the boiler (B).
7. Whilst taking care - lift the tank unit out from the cabinet and place it on the countertop.
8. Unscrew and detach connector D (at red outlet) from the top of the boiler. If overtight, an adjustable spanner can be used to loosen.

DESCALING YOUR APPLIANCE

9. If the 3/8" rubber seal (E) becomes detached from the red outlet wing nut connector (D) then reinsert the seal inside connector.

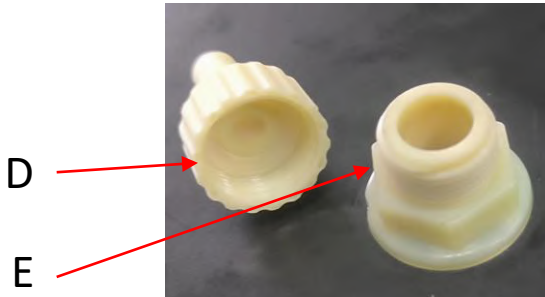

10. Each sachet of descaling powder contains 200g. Using a measuring jug and spoon, stir the whole of the sachet with 300ml of cold water. Taking care, stir contents until fully dissolved. Allow to sit whilst the next steps are taken.
11. Tip the boiler upside down so that the boiler's centre outlet (F) is over the sink, you must empty the boiler as much as possible of water and any debris, tip the boiler back and forth to hear how much water remains inside if you are unsure.
12. Stir your descaling solution again - to check it is dissolved.
13. Place the funnel into the inlet (F) and slowly pour in 300ml of solution.



Take care not to try to overfill too quickly as you may create an air lock.

DESCALING YOUR APPLIANCE

14. Place boiler back under sink and reconnect all the removed parts from the boiler in the reverse order listed above. CONNECTIONS SHOULD BE HAND TIGHTENED PLUS A ¼ TURN WITH A SPANNER.

NOTE – IF THE BOILER AUTOMATICALLY SWITCHES ON, USE POWER TO TURN BACK IN TO STAND-BY MODE.



TURN WATER SUPPLY VALVE BACK ON

15. Turn on the 98°C tap handle on, keep the handle on until you see water exit the spout of the tap then turn it off immediately. This may take a couple of minutes. CHECK FOR ANY LEAKS.
16. Press and hold the power button to activate machine, this will turn the boiler back on from “standby” mode.
17. Using the temperature selector - change the target temperature to **85°C**. Wait for the actual temperature to display “**85°C**” onscreen. This may take a few minutes.
18. Once the temperature reaches **85°C** take note of the time and wait for 40 minutes for the descaling liquid to work. It is normal for an odour to be present during this time.
19. Turn the 98°C tap handle on fully, allow to run for at least 20 litres minimum (use a kitchen measuring jug) or until the water stream runs clear.
20. If dirt, debris, or scale remain inside the tank / you notice a lot of scale still rinsing through towards the end of flushing out process we recommend you repeat the process steps 1-21 (as above) again if needed.
21. Should any residual taste from the descaling solution remain, flush additional water through the boiler until it subsides.

ERROR CODES

Error code	Failure	Explanation	Solution
E1	Abnormal temperature sensor	Short circuit or open circuit of temperature sensor	Contact WWW.WATERSOLUTIONSDIRECT.COM
E2	Heating up too fast	Within 5 seconds, the temperature rises by more than 5 degrees	Power off and restart
E3	Lack of water	No water detected by water level probe	Automatic recovery when there is water
E4	Clock fault	Clock chip stops, clock is too fast, clock is too slow	Contact WWW.WATERSOLUTIONSDIRECT.COM
E7	Low temperature	The temperature is between -2 °C and + 2 °C	Automatic recovery when the temperature is achieved
E8	High temperature	The temperature is more than 100 °C	Automatic recovery when the temperature is achieved
E9	A very low temperature	The temperature is below -2 °C	Automatic recovery when the temperature is achieved

TROUBLE SHOOTING

PROBLEM	POSSIBLE CAUSE	SOLUTION
Water and Steam is spitting from the instant hot water tap spout	Unit is boiling	<p>Turn the instant hot water tap handle on and release the water for at least 500ml</p> <p>Adjust the water temperature on the display to a lower setting.</p> <p>Check aerator is not blocked</p> <p>Tank may need a descale</p>
Water is not hot	<p>Machine is not connected to power</p> <p>Electronic display has not powered up</p>	<p>Ensure machine is plugged in and powered up</p> <p>Turn machine off and on again and set the temperature required</p>
Water is too hot	Water temperature setting on display panel is set to high	Re-set the temperature to the required temperature and con-firm the heating up
Water is dripping from the instant hot water tap spout	<p>The expansion chamber isn't draining the system correctly due to very small draw offs of water</p> <p>The spout is blocked</p>	<p>Draw off 1 Litre of water to clear and prime the system. Avoid less than 100ml of a pint draw offs of water.</p> <p>Remove and clean the aerator. Check silicon pipe length. Re-move and clean the aerator.</p> <p>Tank may need a descale</p>

TROUBLE SHOOTING

PROBLEM	POSSIBLE CAUSE	SOLUTION
Slow Flow from the spout	Water Filter may be clogged from impurities in the inlet mains water	The water filter must be changed every 6 months, or this will void the guarantee
	Tank has too much scale	Tank may need a descale
Water flow takes too long to start	The electronic hot water appliance is designed for non-pressurised operation and there will be slight delay till the near boiling water appears	After a large volume of water has been drawn off there may be a slightly longer delay in the water appearing from the instant hot water tap spout
	Tank has too much scale	Tank may need a descale
No water flow	Water Valves have been turned off	Turn on all the water valves
	Inlet Pipes have been twisted or blocked	Ensure the pipes are not twisted or kinked to restrict flow Remove and clean the aerator
	Tank has too much scale	Tank may need a descale

TROUBLE SHOOTING

PROBLEM	POSSIBLE CAUSE	SOLUTION
E3 Error	Tank needs resetting	After E3 appears, press the up, down, and on keys simultaneously - E3 will start flashing. At the same time, the confirm key indicator light will light up. Press the confirm key within 5 seconds to turn off the water level detection function

IF YOU ARE IN ANY DOUBT, TURN OFF APPLIANCE AND
CONTACT
WWW.WATERSOLUTIONSDIRECT.COM
WHERE YOU REGISTERED YOUR PRODUCT FOR ADVICE.



ATTENTION

It is vital to register your product to validate your warranty and help care for your machine to ensure a long life and warranty.

ALL PRODUCTS MUST BE REGISTERED BY THE CONSUMER FOR CUSTOMER SERVICE, SUPPORT & SERVICE PARTS.

REGISTER YOUR PURCHASE

TO ACTIVATE YOUR PRODUCT'S WARRANTY, SIMPLY REGISTER YOUR PRODUCT AT

www.watersolutionsdirect.com



Flushing the Instant Hot Water Tank

It is recommended that the user flushes through the system completely by drawing off the instant hot water and allowing to reheat and repeating the process for a further 2 or 3 times to ensure the system is fully operational.

Water Draw Back and Contamination in the Tank

During the filling of any vessel the user must ensure, at all times, that the spout outlet is not submerged in the water during the dispensing of the instant hot water and especially when the instant hot water handle is released.

Maintenance & Power Saving

If the electronic instant hot water appliance is not being used for long periods of time i.e.: over 2 days, to save power we recommend you switch off using the “ON/OFF” switch.

Seasonal Shutdown

The hot water system (tank and tap) must not be exposed to freezing temperatures. If there is a possibility of this the system must be drained of water. Shut-off the mains supply and unplug the unit from the electricity mains and allow the tank to cool for at least 1 hour. Disconnect the inlet supply to the tank and remove the silicone hose outlet pipe, lift the unit to the sink, turn upside down and drain all the water from the tank.

When reinstalling follow the original installation instructions.

NOTICE

The electronic instant hot water appliance like any water heater has a limited operational life span and will eventually fail. In order to ensure maximum protection and to avoid possible damage to any property or personal injury the electronic instant hot water appliance should be inspected regularly for any water leakage or damage.

Regularly check for any signs of water leakage, if there is any water leakage then replace any loose or split silicon tubes or flexi tails which can cause water leakage and damage.

To provide additional water security to avoid property damage the electronic instant hot water appliance can be placed in a drain pan and connected to a suitable drain outlet to avoid any water damage. The drain pan should be installed using the manufacturers installation instructions

DISPOSAL



Information on Disposal for Users of Waste Electrical & Electronic Equipment (private households)

This symbol on the product and / or accompanying documents means that used electrical and electronic products should not be mixed with general household waste. For proper treatment, recovery and recycling, please take this product to designated collection points where it will be accepted free of charge. Alternatively, in some countries you may be able to return your products to your local retailer upon purchase of an equivalent new product. Disposing of this product correctly will help save valuable resources and prevent any potential negative effects on human health and the environment, which could otherwise arise from inappropriate waste handling.

Please contact your local authority for further details of your nearest designated collection point.

Penalties may be applicable for incorrect disposal of this waste, in accordance with your national legislation.

For business users in the European Union

If you wish to discard electrical and electronic equipment, please contact your dealer or supplier for further information.

Information on Disposal in other Countries outside the European Union

This symbol is only valid in the European Union. If you wish to discard this product, please contact your local authorities or dealer and ask for the correct method of disposal.